



Gamma di proiettori per binari elettrificati dal design conico compatto ed essenziale, caratterizzata da alto rendimento luminoso e bassi consumi. **Merlino** è in grado di illuminare qualsiasi tipo di ambiente in negozi, centri commerciali, showroom e gallerie d'arte, combinando luce d'accento con elevate prestazioni.

Proposto in due dimensioni e con fonti luminose differenti tra cui LED COB di ultima generazione, è applicabile su binari trifase LKM, monofase MM e con base, per parete o soffitto.

Range of compact, conical and essential spotlights for electrified tracks with high luminous output and low energy consumption. **Merlino** can enlighten almost any type of environment in retail and also in shopping centres, showrooms and art galleries, combining accent lighting with great performance.

Available in two sizes and with different types of lamps, such as the last generation of COB LEDs, it can be applied on LKM three phase tracks, MM single phase tracks and with base for wall or ceiling mounting.

■ Corpo e anello frontale in pressofusione di alluminio verniciato poliesteri

Riflettore in termoplastico metallizzato a specchio per Merlino 110 LED o in alluminio purissimo 99,9 brillantato per le altre versioni

Vetro di protezione temprato per Merlino 150 G12 e Merlino 110 G8.5 e GU5.3

Alimentazione elettronica integrata

■ Body and front ring in die-cast aluminium, polyester painted

Reflector in mirror metallized thermoplastic for Merlino 110 LED or in pure 99.9 polished aluminium for the other versions

Tempered safety glass for Merlino 150 G12 and Merlino 110 G8.5 and GU5.3

Integrated electronic supply

■ Indice di resa cromatica:
Ra > 85 (per Merlino 110 LED)
Tensione di alimentazione:
230/240V – 50/60Hz

■ Color rendering index:
Ra > 85 (for Merlino 110 LED)
Supply voltage:
230/240V – 50/60Hz





Merlino può essere orientato fino a un'ampiezza di rotazione di 350° rispetto all'asse orizzontale e a quello verticale.

Merlino can rotate and pivot up to 350°. With respect to the horizontal and to the vertical axis.

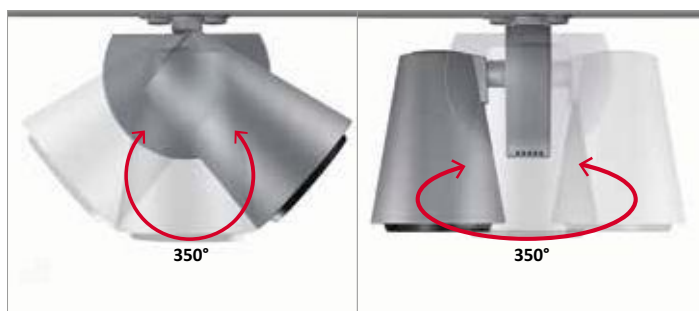

Ottiche professionali sostituibili senza bisogno di attrezzi
Professional optics for different beam angles. No tools needed.

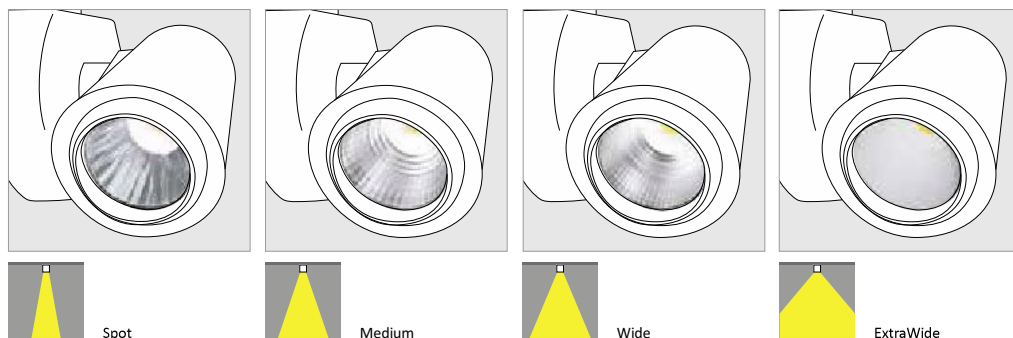

MERLINO 110 LED

Codice Code Lampada Lamp lumen Watt Colour T (K) Fascio Beam



Per binari trifase LKM
For 3-phase tracks LKM

791-311	LED	3400	33	3000	30°
791-411	LED	4200	36	3000	25°

21

Bianco mat
Mat white

52

Metal
Silver

16

Nero su richiesta
Black on demand

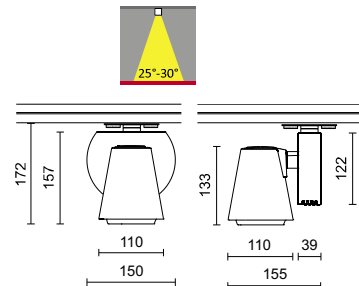

1,7

ACCESSORI ACCESSORIES

Ottiche professionali in termoplastico metallizzato a specchio o bianco (per 70°)
Professional optic device in thermoplastic mirror metallized or white (for 70°)

Cod	3400 lm	4200 lm
28-3140		
28-3142		
28-3138		
28-3141		

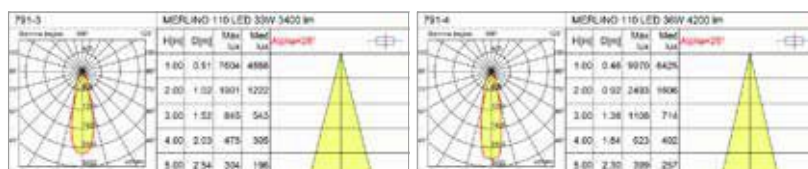

MERLINO 110



Codice Code Lampada Lamp Watt Attacco Base Fascio Beam

Per binari trifase LKM
For 3-phase tracks LKM

791-112	CDM-TC	70	G8.5	15°
792-112	CDM-TC	35	G8.5	11°
792-212	HR	50	GU5.3	-

Per binari monofase MM
For single-phase tracks MM

791-132	CDM-TC	70	G8.5	15°
----------------	--------	----	------	-----

Con base
With base

791-122	CDM-TC	70	G8.5	15°
792-122	CDM-TC	35	G8.5	11°
792-222	HR	50	GU5.3	-

- 21
Bianco mat
Mat white
- 52
Metal
Silver
- 16
Nero su richiesta
Black on demand

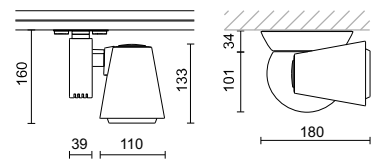
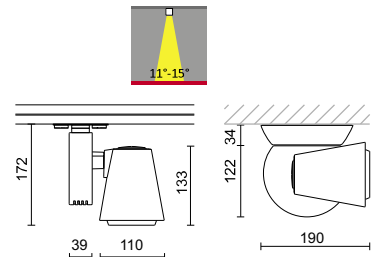

1,0

ACCESSORI ACCESSORIES

Ottiche professionali in alluminio purissimo 99.9 finitura brillantata ad alto rendimento
Professional optic device in 99.9 pure aluminium high-efficiency polished finish

Cod **CDM-TC 35-70W G8.5**

28-0881

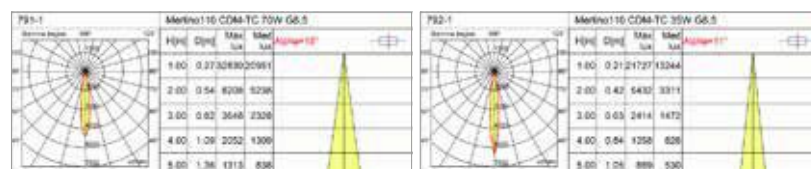

MERLINO 150



Codice Code Lampada Lamp Watt Attacco Base Fascio Beam

Per binari trifase LKM
For 3-phase tracks LKM

790-112	MT	70	G12	17°
790-212	MT	150	G12	22°
790-512	HM R111	100	G53	-

Con base
With base

790-122	MT	70	G12	17°
790-222	MT	150	G12	22°
790-522	HM R111	100	G53	-

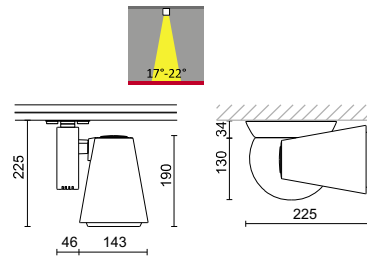

1,8 Kg

- 21
Bianco mat
Mat white
- 52
Metal
Silver
- 16
Nero su richiesta
Black on demand



ACCESSORI ACCESSORIES

Ottiche professionali in alluminio purissimo 99.9 finitura brillantata ad alto rendimento
Professional optic device in 99.9 pure aluminium high-efficiency polished finish

Cod **MT 70-150W G12**

28-0880

