

COSMO DELTA LED

- **protection degree:** IP 66, for optical part and driver
- **insulation class:** II
- **power supply voltage:** 220-240 V AC, 50/60 Hz
- **light sources:** CREE XP-L
- **material:** anodized aluminum alloy
- **colour:** inox/graphite
- **mounting:** on columns with spigot ending Ø60 mm length 85 mm
- **recommended assembly height:** 6-8m
- luminaire is adapter to work in temperatures between -40°C and +55°C

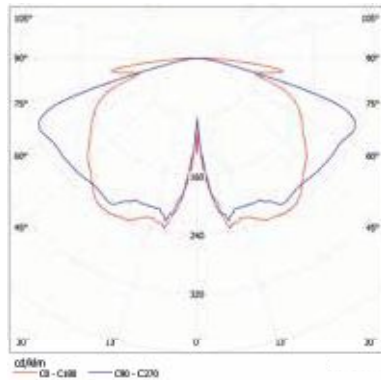

Light distribution curve for COSMO DELTA LED luminaire

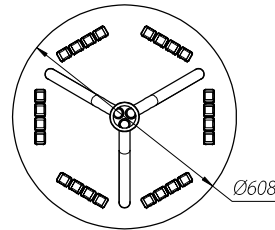
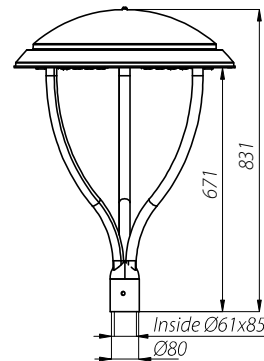

COSMO DELTA LED



COSMO DELTA LED



COSMO DELTA LED ASYMMETRIC



Luminaire COSMO DELTA LED on column SAL DL-3 height of 6 m

Name	The colour temperature of ligh [K]	Code	Power / Number of LEDs [W / pcs.]	Total power [W]	Luminous flux [lm]*	Lighting efficiency [lm/W]	Weight [kg]	Current product card
COSMO DELTA LED	5 000	214835/6	72/24	80	9 750	122	11	
	3 500	214835/3			8 950	112		
COSMO DELTA LED ASYMETRYCZNA	5 000	2148035/6	72/24	80	9 750	122	11	
	3 500	2148035/3			8 950	112		

* due to LEDs precision class, the value tolerance is +/-7%

COSMO DELTA LED

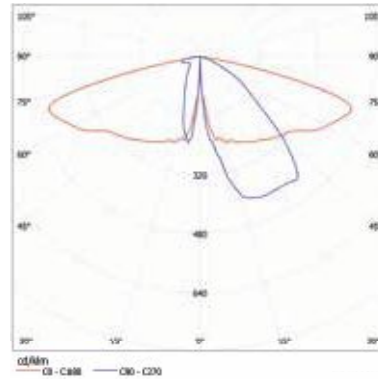

Light distribution curve for COSMO DELTA LED ASYMMETRIC luminaire DW

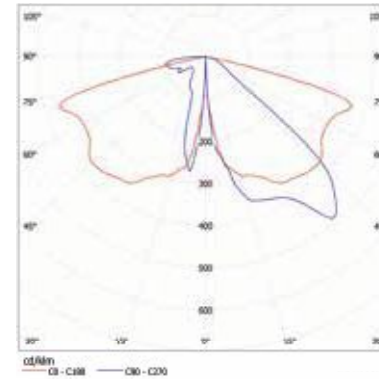

Light distribution curve for COSMO DELTA LED ASYMMETRIC luminaire ME

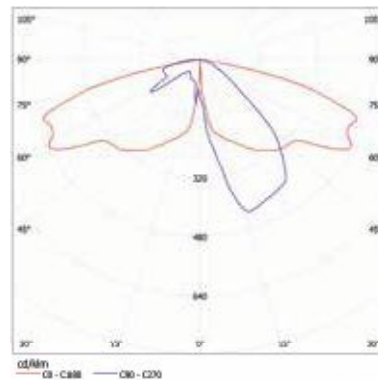

Light distribution curve for COSMO DELTA LED ASYMMETRIC luminaire T2

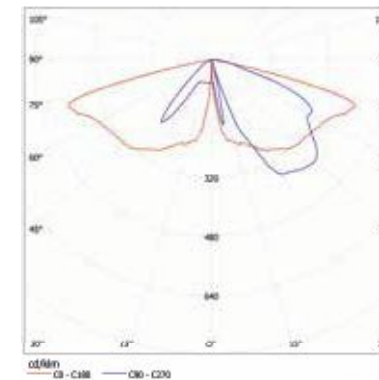

Light distribution curve for COSMO DELTA LED ASYMMETRIC luminaire T3

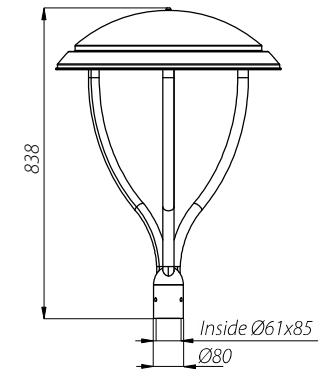
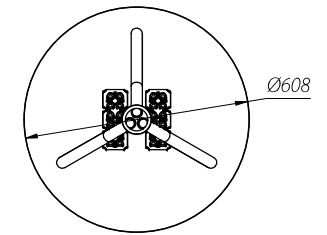

COSMO DELTA LED ASYMMETRIC